

Heavy Duty Door Unloader DT-540

The Dotul Heavy Duty Door Unloader is used to offload doors from a vertical door machine on to an assembly table or door cart. The unloader eliminates the need for the operator to physically pick up the door, rotate the door and place it on an assembly table. Built into the operation of the unloader is a feature which allows the operator to stand the door straight up once the door has been positioned on the unloader. This gives the operator an ergonomically friendly lifting position so the door can be placed on a door cart or rack.

Features and Benefits

- Compatible with most vertical door machines
- Vertical unloading capability makes it ergonomically friendly for loading door carts
- Machine will rotate 360 degrees in the horizontal position, with 90 degree locking points
- Quick release handle for tilting or rotating operation
- Easy adjustable roller positioning
- Connecting arms with rollers allow the door to easily be transferred from a door machine to the unloader without lifting
- Adjustable infeed and outfeed height allow the unloader to be used with most vertical door machines or assembly tables
- Foot control for tilting operation makes it easy for the operator
- No electrical power supply required, air only

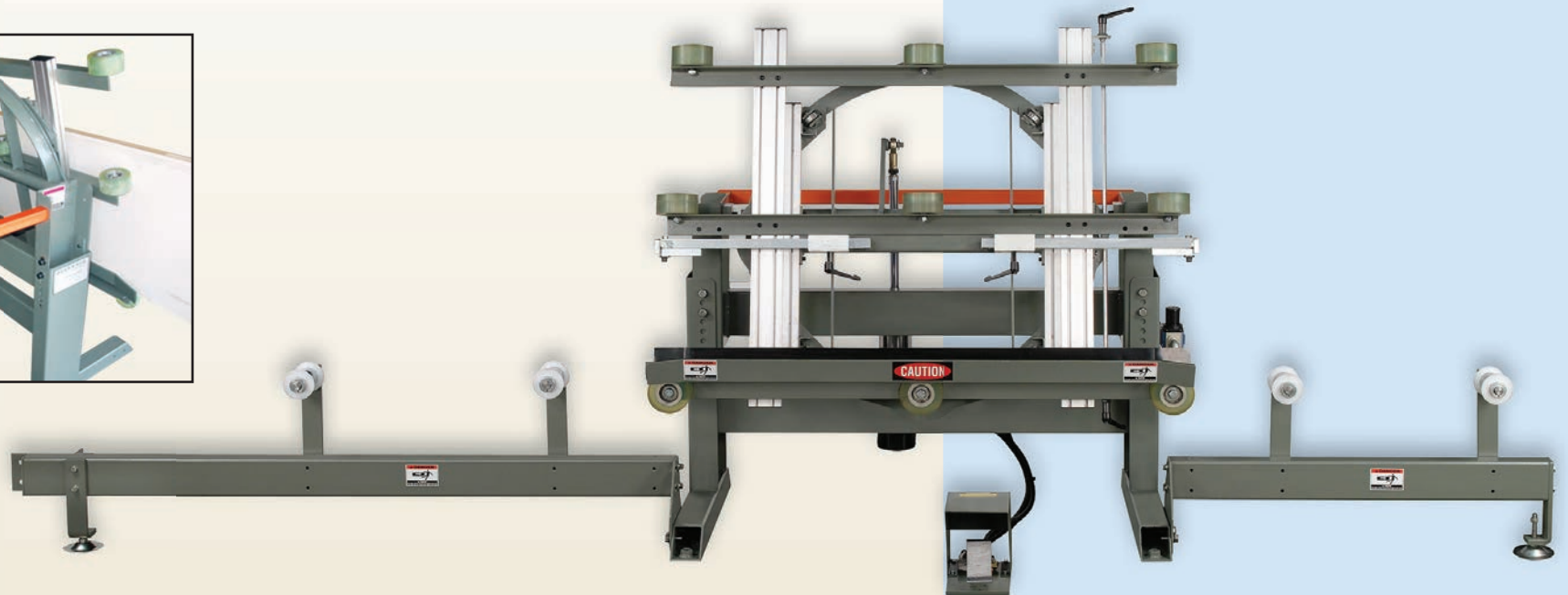

SPECIFICATIONS

Door Width - Up to 48"

Door Height - Up to 108"

Door Thickness - up to 2¼"

Door Weight - up to 200 lbs

Infeed Roller Height Adjustment - 8" to 14"

Outfeed Height Adjustment - 36" to 41"

Connector Roller Lengths - (1) 64", (1) 36"





Unloader Dimensions - W 42" x L 52" x H 32"-40"

Unloader Weight - 650 lbs

Air Supply Required - 90 psi

Dotul Distributors Map
January 2015

DÖTUL
intelligent door building machinery

-   Global Sales Group, LLC
-   Akhurst Machinery
-  Dotul

Member



Member



Member

MSLBMDA

Represented By:

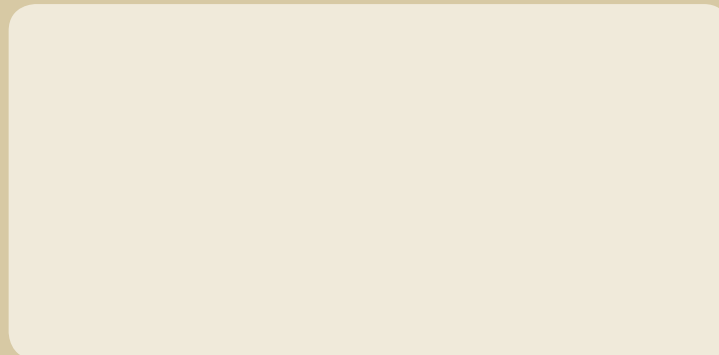

Global Sales Group, LLC
P.O. Box 1835 Chico, CA 95927
Toll Free (USA & Canada): 877-474-5521
Office: 530-893-2444
Fax: 530-893-2244
info@globalsalesgroupllc.com
www.globalsalesgroupllc.com

Akhurst Machinery
1669 Foster's Way
Delta, BC V3M 6S7
Tel: (604) 540-1430
Toll Free: 1-888-265-4826
Fax: (604) 540-1780
Email: van@akhurst.com



Please visit our YouTube channel for more information on our products: **Global Sales Group LLC**